

SP400X Series

SP400X Scanner Printer System Administrator Guide



handheld

Copyright information

(c) Copyright 2012 Handheld Group

The information contained herein is subject to change without notice. The only warranties for Handheld products and services are set forth in the express warranty statements accompanying such products and services. Nothing herein should be construed as constituting an additional warranty. Handheld shall not be liable for technical or editorial errors or omissions contained herein.

Trademark credits

Microsoft and Windows are U.S. registered trademarks of Microsoft Corporation.

Adaptus Imaging Technology is a registered trademark of Honeywell International, Inc.

The Bluetooth word, mark, and logos are owned by the Bluetooth SIG, Inc.



Contents

1. INTRODUCTION	
About this guide.....	6
The SP400X briefly explained.....	6
Handle and wireless options.....	6
Handle options.....	6
Wireless connectivity.....	6
SP400X components.....	7
Hand mount components.....	8
Control panel components.....	9
2. SAFETY INFORMATION	
General safety.....	10
LED safety.....	10
Battery safety.....	10
3. SET UP THE SP400X	
Install the battery cable.....	11
Assemble the hand mount or handle accessory.....	11
Install the print cartridge.....	12
Install the battery and fit the wrist case.....	14
Fit the hand mount.....	16
Connect the battery cable.....	18
4. CONFIGURE THE SP400X	
Overview.....	19
Implement the server application.....	19
Configure the SP400X.....	19
Design a custom print template.....	20
5. OPERATE THE SP400X	
Turn on the SP400X.....	21
Scan.....	22
Scan instructions.....	22
Scanning tips.....	23
Print.....	24
Print instructions.....	24
Printing tips.....	24
Clear print data.....	25
Turn off the SP400X.....	26
Remove the SP400X and wrist case.....	26
6. MAXIMIZE PRINT QUALITY	
Materials and technique.....	27
7. ENSURE OPTIMAL COMFORT	
Ergonomic recommendations.....	28
8. MAINTAIN THE SP400X	
Order supplies and accessories.....	29
Condition the battery.....	29
Clean the SP400X.....	30
Cleaning materials.....	30
Clean outside surfaces.....	30

Clean the imager window.....	30
Clean the wrist case and hand mount.....	31
Clean the door.....	31
Charge the battery.....	31
Remove the hand mount or handle accessory.....	31
Replace the battery cable.....	32
Replace the finger strap.....	32
Replace the wrist strap.....	33
Replace the rear buckle.....	34
Replace the door.....	35
Recycle.....	35
Locate the serial number.....	35
9. TROUBLESHOOT PROBLEMS AND GET SUPPORT	
Problems powering the SP400X on.....	36
Problems connecting the SP400X to a wireless network.....	36
Problems scanning.....	37
Problems printing.....	38
Problems printing correctly.....	39
Errors and warning conditions.....	41
General errors and warning conditions.....	41
Battery errors and warning conditions.....	42
Print cartridge errors and warning conditions.....	43
Scanning/Wireless errors and warning conditions.....	45
Support services.....	47
10. ADVANCED USE	
System requirements.....	48
Download and install software.....	48
Set up the wireless network.....	48
802.11b wireless.....	48
Configure the server.....	49
Design print templates.....	49
Use the default print templates.....	49
Calibrate the scanner.....	51
Reset the standard product defaults.....	51
Update firmware through USB.....	51
Update firmware wirelessly.....	52
11. SP400X SPECIFICATIONS	
General device specifications.....	53
Environmental specifications.....	53
Wireless specifications.....	53
Range of wireless module.....	53
Other specifications.....	54
12. WARRANTY AND REGULATORY INFORMATION	
Warranty.....	56
Regulatory notices.....	56
U.S.A.....	56
Federal Communications Commission notice.....	56
Modifications.....	56
Canada.....	56
European Union notices.....	56
Products with 2.4-GHz wireless LAN devices.....	57
France.....	57

Italy.....	57
Wireless LAN 802.11b devices.....	57
International.....	57

1. Introduction

About this guide

This guide provides information that users and system administrators need to set up and maintain the Handheld SP400X.

The SP400X briefly explained

The Handheld SP400X lets you scan and print in almost any location in your environment. The entire unit, including power source, attaches comfortably to your hand and arm so you can move around while working. The SP400X can also communicate wirelessly with a server to exchange scan and print information.

Handle and wireless options

Handle options

There are two options for holding the SP400X during use:

- Hand mount
- Handle accessory

Instructions for using the hand mount are included in this guide; instructions for using the handle accessory are in the box with the handle accessory.

Wireless connectivity

Wireless connectivity can be accomplished in two ways:

- 802.11b LAN wireless
- 802.11 b/g/n

Instructions for using 802.11b wireless are included in this guide; instructions for using Bluetooth are available online at www.handheldgroup.com/manuals.

SP400X components

The Handheld SP400X is designed to be worn comfortably on the hand and arm when performing scanning, printing, and package handling tasks.

The SP400X consists of the following key components:

- A battery
- Installed inside a forearm-mounted wrist case; or
- Installed into the bottom of a handle accessory
- The scanner printer device
- Attached to a hand mount; or
- Attached to a handle accessory

! **IMPORTANT:** If you are using the handle accessory instead of the hand mount, see the instructions that were included with the handle accessory.

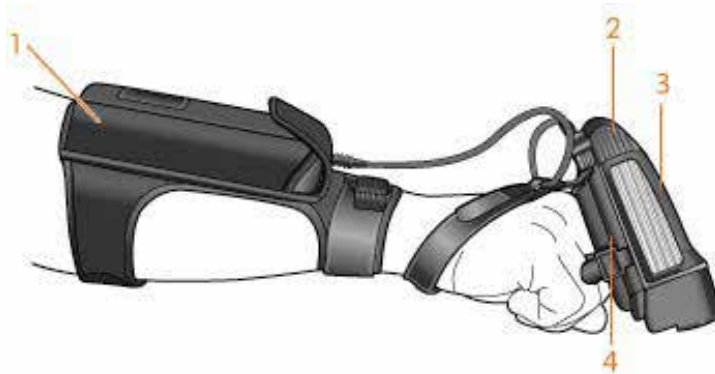

1. Battery inside wrist case
2. Control panel
3. SP400X
4. Hand mount

Hand mount components

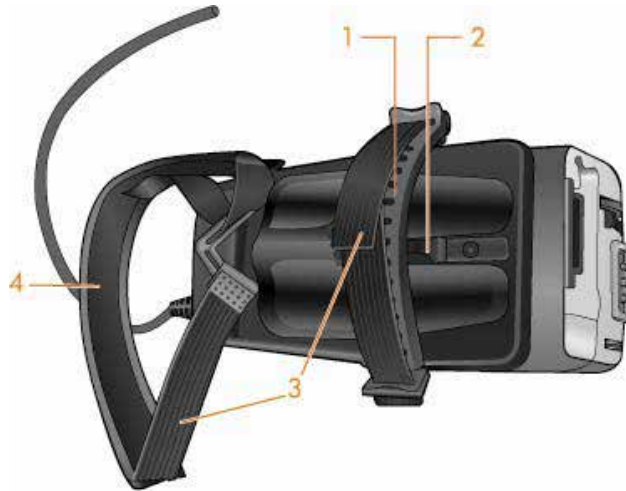

1. Finger strap
2. Rudder
3. Strap fasteners
4. Wrist strap

Control panel components

The SP400X control panel displays several buttons and LED lights for operation and visual feedback.

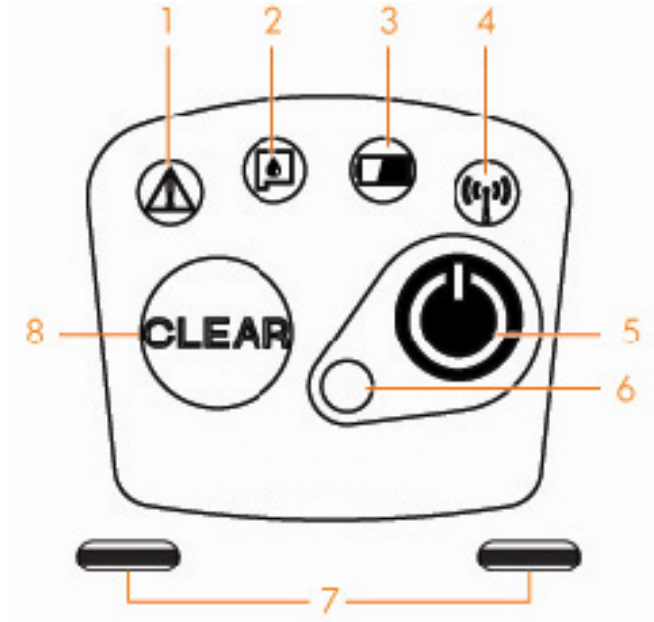

- | | |
|-----------------------------------|---|
| 1. Error light (red) | 5. Power button |
| 2. Print cartridge light (orange) | 6. Power light (green) |
| 3. Battery light (orange) | 7. Tail lights (green or red) on back corners of SP400X |
| 4. Wireless light (blue) | 8. CLEAR button |

2. Safety information

General safety

**CAUTION:**

- The Handheld SP400X is meant for hand-held or hand-mounted use only. It is not intended or authorized for operation within 20 centimeters (8 inches) of the head or torso.
- Do not submerge this device in water.
- If you experience discomfort, discontinue use of the SP400X and notify your supervisor immediately. If you experience persistent or recurring pain or discomfort that you think may be related to using the SP400X, you should promptly consult a qualified physician and, if available, your company's health and safety department.

LED safety

The scanning imager located on this device is classified as a Class 1 LED device according to International Standard IEC 825-1 (EN60825-1). The following precautions are recommended:

**CAUTION:**

- If the unit requires service, contact an authorized Handheld service center.
- Do not attempt to make any adjustment to the LED imaging scanner.
- Avoid looking into the LED imaging scanner.
- Do not attempt to view the LED imaging scanner with any type of optical device.

Battery safety

**CAUTION:**

- There is a risk of explosion if the battery is replaced by an incorrect type.
- Use only the following Handheld battery: product number CE199B.
- When discarding old batteries, contact your local waste-disposal provider regarding local restrictions on the disposal or recycling of batteries.
- Only use Hewlett-Packard approved accessories and UL recognized battery packs and chargers.
- To reduce the risk of fire or burns, do not disassemble, crush, or puncture a battery; short the external contacts on a battery; or dispose of a battery in fire or water. Do not expose a battery to temperatures above 60 °C (140 °F).

3. Set up the SP400X

Install the battery cable

Insert the battery cable into the bottom of the hand mount, as shown.

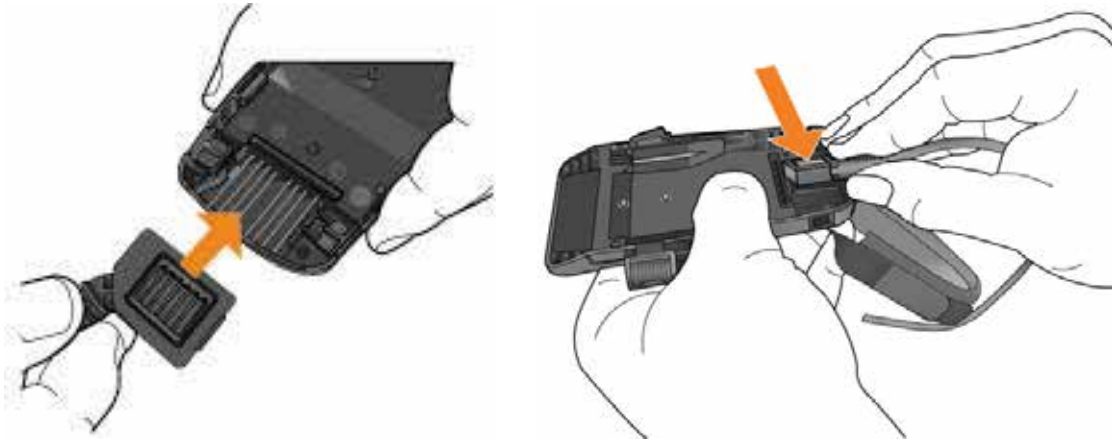

Assemble the hand mount or handle accessory

1. Align the hand mount with the SP400X as shown.
2. Slide the hand mount until it clicks into place.

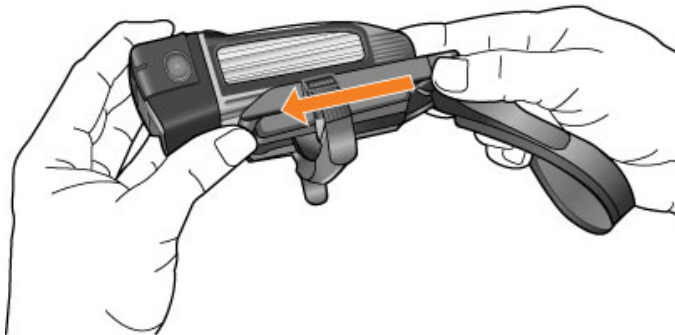

! **IMPORTANT:** If you are using the handle accessory instead of the hand mount, see the instructions that were included with the handle accessory.

Install the print cartridge

1. Turn off the SP400X by pressing and holding the green Power button for three seconds if it is not already off.

! **IMPORTANT:** Always turn the SP400X off before installing a print cartridge.

2. Remove the protective tape from the print cartridge by pulling it straight out.

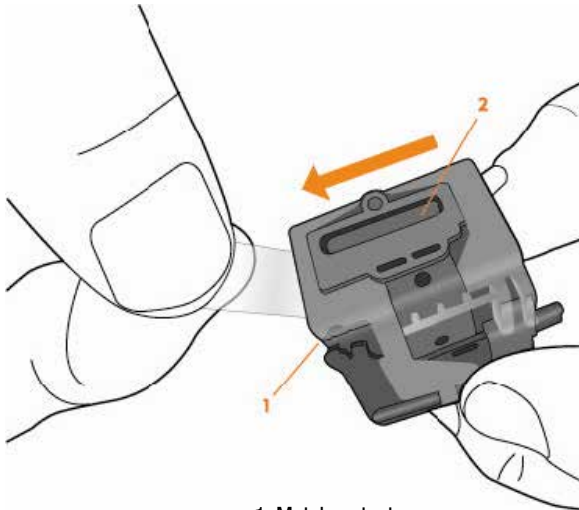

1. Metal contacts

2. Ink nozzles

! **IMPORTANT:** Hold the print cartridge by its sides, as shown above. Do not touch the metal contacts or the ink nozzles.

3. Push the side button to release the door, and swing the door open.

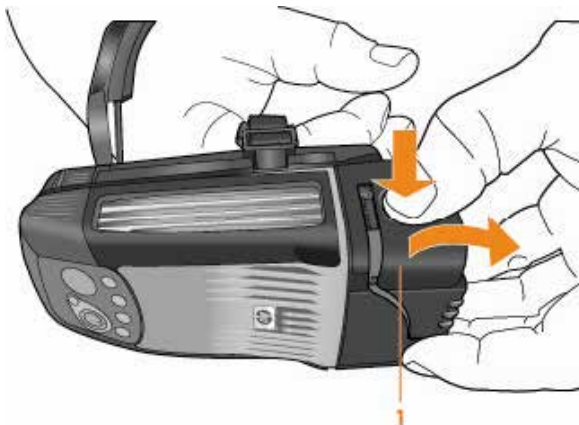

1. Door

4. Align the print cartridge with the drawing on the door, and then carefully seat the cartridge in the door. The label on the print cartridge should face away from the door. The metal contacts should face the SP400X.

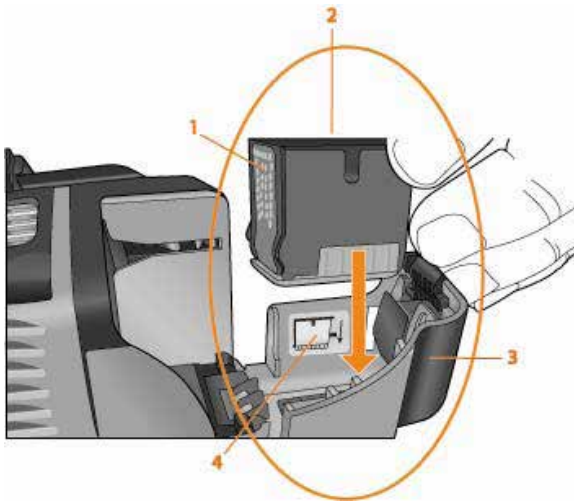

1. Metal contacts
2. Label
3. Door
4. Drawing

5. Close the door, ensuring it latches securely.

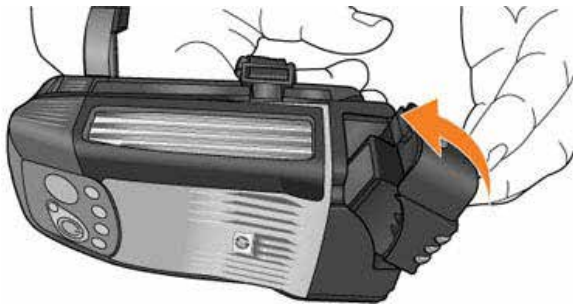

Install the battery and fit the wrist case

! **IMPORTANT:** Remove all jewelry from your wrist and hand before fitting the SP400X.

1. Insert a fresh battery as shown.

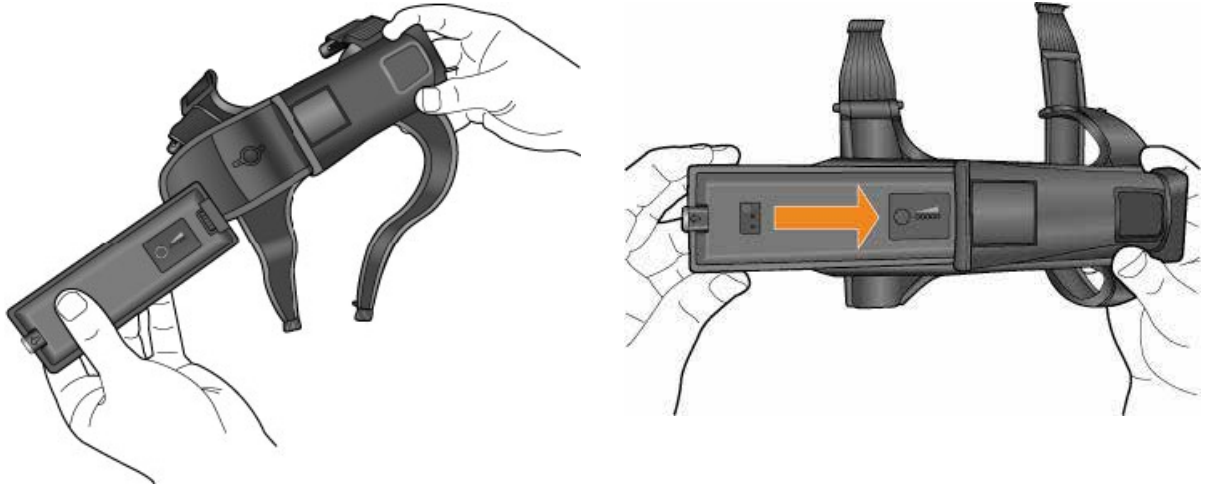

2. Secure the flap to retain the battery.

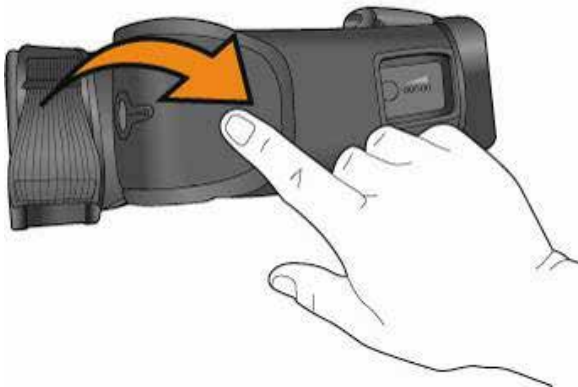

3. Position the front strap behind your wrist.

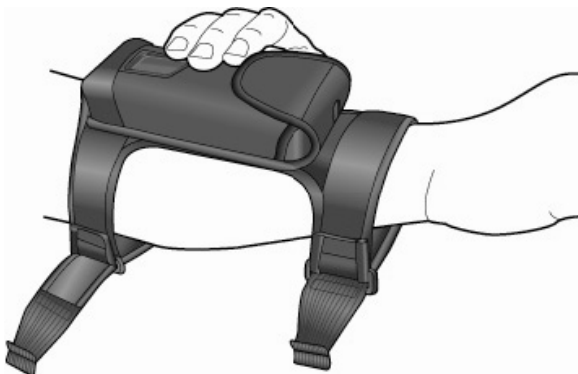

4. Secure the arm straps.



1. Battery gauge

NOTE: The battery gauge should face upward and be visible through the cutout on top of the battery wrist case.



CAUTION: Do not over-tighten the straps. Over-tightening can cause discomfort.

Fit the hand mount

! **IMPORTANT:** Remove all jewelry from your wrist and hand before fitting the SP400X.

1. Loosen the finger strap by detaching the fastener ends and then rotating the buckles outward so that the strap can slip freely through the buckles.



2. Center the rubberized portion of the finger strap between the buckles.

3. Loosen the wrist strap by releasing the fastener ends and pulling the straps through the buckles.

4. Slide your hand through the wrist strap, palm away from the SP400X.

5. Insert pointer and middle fingers under the finger strap with the rudder positioned between the two fingers.

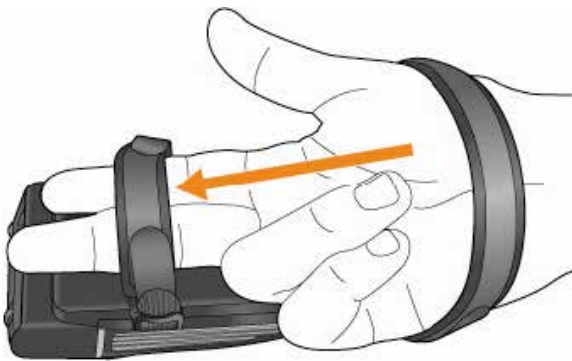

6. Slide the SP400X onto your hand until the finger strap is at the base of your fingers, and the wrist strap is at the wrist.

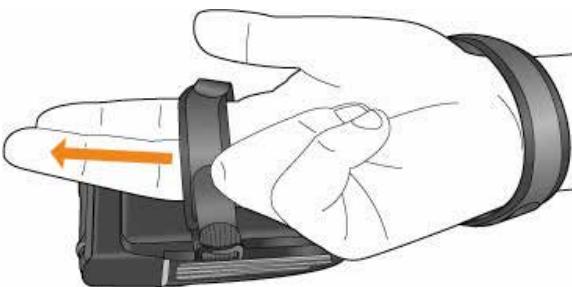

7. Tighten the finger strap by pulling straight up from the buckle until there is no movement between the hand and the SP400X and then secure the fastener ends to lock the finger strap in place.

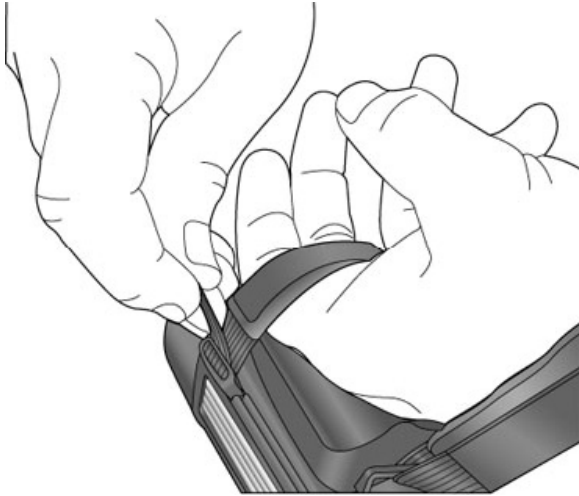

! **IMPORTANT:** The finger strap must be tight enough to prevent motion between the fingers and the SP400X because under-tightening may lead to irritation. Do not over-tighten to the point that numbness or discomfort results.

NOTE: To loosen the finger strap, release the fastener strap and rotate the buckle outwards until it is at a 90-degree angle to the SP400X, as shown in step #1. Then pull the strap with your fingers until it is comfortable.

8. To tighten the wrist strap, bend the wrist upward while making a relaxed fist, and then pull the strap until the SP400X makes light contact with the knuckles. Light tension is sufficient.



! **CAUTION:** Do not over-tighten the wrist strap. It should not create pressure on the knuckles.

Connect the battery cable

IMPORTANT: Use only the following Handheld battery: product number CE199B.

1. Align the arrow on the battery cable connector with the top of the battery case.
2. Push in to connect the battery cable to the battery.

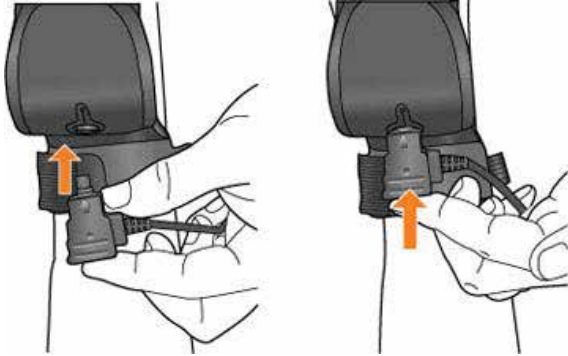

4. Configure the SP400X

Overview

The SP400X is designed for use with a server-based application that sends print data in response to scan data received from the SP400X. The general process is as follows:

1. When turned on, the SP400X attempts to register with the server using network and server configuration parameters that are stored in the SP400X.
2. The SP400X queries the server for any updates (firmware or configuration, for example).
3. The SP400X is ready to scan.
4. After scanning a bar code, the SP400X sends the information contained in the bar code to the server.
5. The server responds with print data.
6. When the SP400X receives the print data, the SP400X signals the user that it is ready to print.
7. After printing (or timing out) the SP400X is ready to scan again.

In order to perform this scan-print process, several steps must be taken to ensure that all of the devices in the process can communicate with each other. These steps are as follows:

- Implement the server application. Refer to the Scan Print Protocol document, available at www.handheldgroup.com/manuals.
- Configure the SP400X devices to communicate with the server application.
- Design the print templates.
- Configure the server application and SP400X devices to receive wireless updates (optional).

Implement the server application

The communication between the server application and the SP400X is implemented using the SP400X Scan Print Protocol (SPP). SPP is an ASCII-based protocol that contains a number of command and response pairs used to communicate with and configure the SP400X.

A number of factors must be considered when designing the server application. The primary considerations are the number of devices that will be communicating with the server, and the desired response time of the server application.

Refer to the Communication Protocols document for a detailed explanation of the protocol that needs to be implemented on the server. It is available at www.handheldgroup.com/manuals. In addition, a sample server application is available for download from this website.

Configure the SP400X

Handheld SP400X Series Configuration Software is available for download at the SP400X website (www.handheldgroup.com/manuals).

This Windows®-based software is used to configure the necessary device settings so that the SP400X can communicate with the server application. The settings that need to be configured fall into three categories:

- Wireless settings: security type, ESSID and Encryption keys
- Server settings: primary and alternate registration servers, file server, application name
- Application settings: application name, print template

The Handheld SP400X Series Configuration Software connects to an SP400X device using a USB cable. The software allows the user to configure the above settings and perform diagnostic and maintenance functions on the SP400X.

Refer to the Handheld SP400X Series Configuration Users Guide for details on installing and using this software. It is available at www.handheldgroup.com/manuals. For brief instructions on configuring the server, see “CONFIGURE THE SERVER.”

Design a custom print template

Handheld SP400X Template Design Software is available for download at the SP400X website (www.handheldgroup.com/manuals). This Windows-based software is used to design a custom print template for your particular needs. It allows the user to create templates that consist of static text and graphics and also dynamic text fields. The design software merges all the text and graphics into a single template which is stored on the device.

The Handheld SP400X Series Template Design Software connects to the SP400X using a cable. The software allows the user to design and download templates and to perform maintenance functions.

Refer to the *Handheld SP400X Series Template Design Software Users Guide* for details on installing and using this application, available at www.handheldgroup.com/manuals. For brief instructions on designing print templates, see “DESIGN PRINT TEMPLATES.”

5. Operate the SP400X

Turn on the SP400X

Press the green Power button and hold for one second.

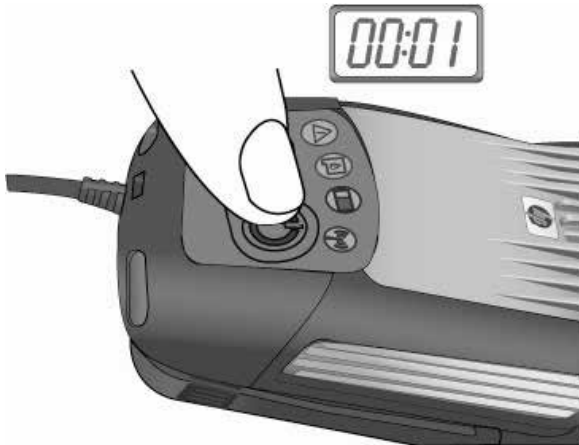

- All lights on the control panel and the tail lights will blink once, and the SP400X will emit a tone.
- The green Power light will continue to blink until the SP400X completes its initialization phase.
- The blue Wireless light will blink until the SP400X establishes wireless connectivity.
When connected, the SP400X will emit a Lo-Hi tone.

The SP400X is ready for use when the green Power light and the blue Wireless light stop blinking and remain solid.

Scan

Scan instructions

The SP400X can scan most one-dimensional and two-dimensional bar code symbologies.

See “*SP400X specifications*” for a complete list.

1. Aim the green light bar at the bar code.



2. Hold the SP400X 6 - 9 inches from the bar code.
3. Hold the SP400X at a slight angle (approximately 5 degrees) to the scan surface.

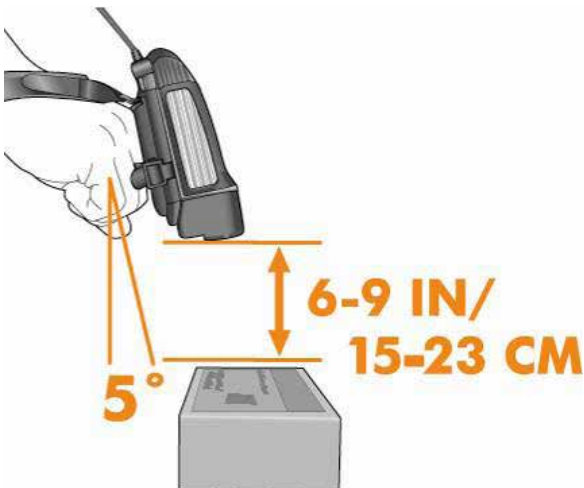

NOTE: Hold steady for best results.

When the scan is complete, the imager light will turn off, and the SP400X will emit a Hi tone.

When the SP400X is ready to print, it will display green tail lights and emit a Hi tone.

NOTE: There are two ways to clear the bar code or symbol and prepare the SP400X to scan again:

- Press the yellow CLEAR button. The red tail lights will flash once and the SP400X will emit a tone.
- Wait for the SP400X to time out and erase the scan from the memory. The SP400X will emit a Hi-Lo tone and the red tail lights will flash once.

Scanning tips

- The SP400X's scanner is similar to a digital camera in that it takes digital pictures of a bar code. Like a digital camera, the scanner should be held as still as possible when reading a bar code.
- The green light bar should be approximately centered on the bar code.
- The green light bar should cover approximately 3/4 of a wide linear bar code.
- The SP400X is capable of reading bar codes at a distance of from 2 - 12 inches, but 6 - 9 inches is the ideal range. Actual reading distances may vary depending on the dimensions of the bar code.
- Reading bar codes straight on is appropriate in many cases, but the reflected light can interfere with reading. Holding the SP400X at an angle of about 5 degrees to the bar code may give better results.
- The SP400X reads bar codes in an omnidirectional manner. This means the SP400X does not need to be pointed in the same direction as the bar code.



The green light bar should be approximately centered on the bar code and cover approximately 3/4 of a wide bar code

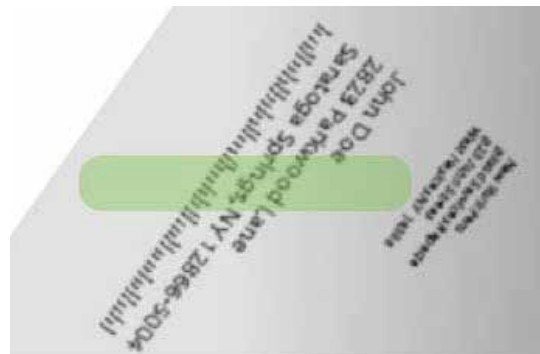

The SP400X reads bar codes in an omnidirectional manner

Print

Print instructions

1. Locate a clean, flat surface near the bar code for printing.
2. Place the nose of the SP400X against the surface. The SP400X should rest at an angle of about 7 degrees from vertical.
3. Move the SP400X straight across the surface.
4. When the print is finished, the green light will turn off and the SP400X will emit a Hi tone.

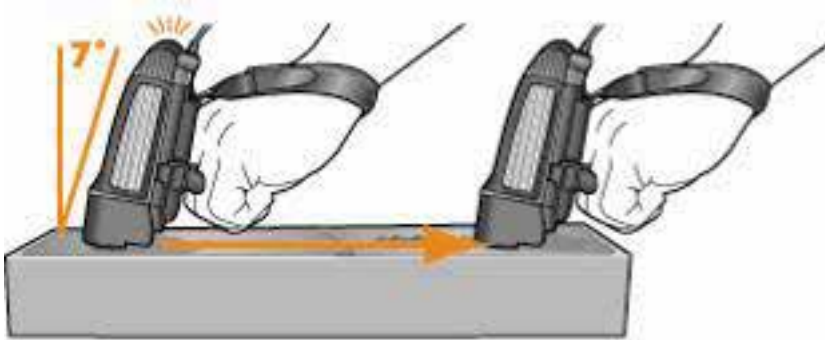

CAUTION: Maintain a relaxed wrist and hand posture and use low force when printing.

Printing tips

IMPORTANT:

- Keep the printer wheel continuously in contact with the print surface while printing.

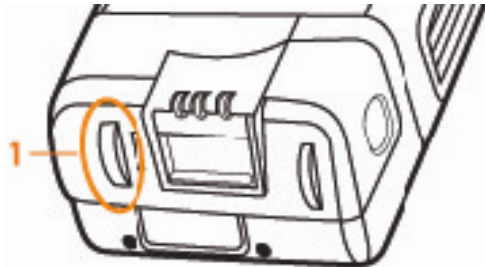

1. Print wheel

- Hold the SP400X so that the angle of the device to the surface is approximately 7 degrees.
- Do not push hard on the surface; light pressure will result in better prints, especially with soft packages.
- Do not rotate your wrist. Rotating your wrist while printing can cause skipping or incomplete prints.

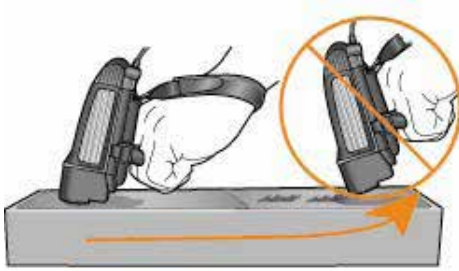

- If you perform a partial or incomplete print, the SP400X will time out, emit a Hi-Lo tone, and the red tail lights will flash once.

Clear print data

If you find that you have an incomplete print or do not wish to print, two options are available:

- Press the yellow CLEAR button on the control panel, then scan and print again. The SP400X will emit a single mid-tone note and the green tail lights will turn off after the CLEAR button is pressed.
- Wait for the SP400X to time out and erase the scan from the memory. The SP400X will emit a Hi-Lo tone and the red tail lights will flash once, letting you know you can scan and print again.

Turn off the SP400X

To turn off the SP400X, press and hold the green Power button for three seconds.

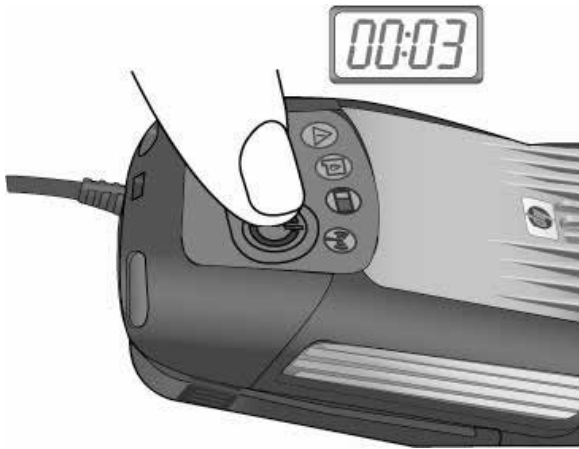

IMPORTANT: Turn off the SP400X before disconnecting the battery cable.

Remove the SP400X and wrist case

1. After turning off the SP400X, grasp the battery cable connector and pull straight out.

! **IMPORTANT:** Do not pull on the battery cable; pull on the battery cable connector that is plugged into the battery.

2. Release the fastener ends of the finger strap.

3. Loosen the finger strap by rotating the front buckle (finger strap buckle) outward about 90 degrees, and then pulling the strap free through the buckles with your fingers. Repeat on the buckle on the other side until the SP400X is loose enough to easily slide your fingers out.

4. Loosen the wrist strap until the hand can slide out freely.

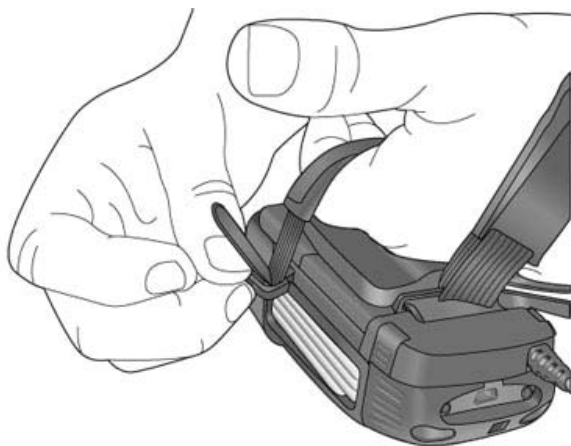

5. Slide the hand and fingers backwards out of the SP400X.

6. Release and loosen the wrist case straps and slide the wrist case off the arm.

6. Maximize print quality

For information about solving print problems, see "PROBLEMS PRINTING."



CAUTION: Handheld ink is not certified for application to people or animals. Do not intentionally print on any part of a person or animal.



CAUTION: Do not print on food. The ink used in the SP400X is not approved for consumption.

Handheld recommends testing the printed images for readability in your environment and on your material. Improving lighting conditions, optimizing font size, increasing the heat and air flow, reducing the humidity of the room, and choosing opaque, light-colored materials can all help improve readability of the printed image.

Materials and technique

For best results, do the following when printing:

- Locate a clean, flat surface near the bar code to print on.
- Hold the SP400X so that the angle of the device to the surface is approximately 7 degrees.
- Pull the SP400X in a straight line until the print is complete; do not rotate wrist or the SP400X during the print.
- Keep the printer wheel continuously in contact with the print surface while printing.
- Maintain a relaxed wrist and hand posture and use low force when printing.
- Maintain a constant speed when printing.

To achieve the best possible readability, consider the following:

- Magenta prints are easier to see than black prints on tan-colored surfaces like cardboard boxes.
- Prints on opaque white material show up best.
- Prints on dark surfaces are not very visible, especially if the surfaces are similar in color.

NOTE: Prints on porous materials like cardboard and paper dry instantly, but prints on non-porous materials can take a few moments to dry.

7. Ensure optimal comfort

Ergonomic recommendations

For optimal results and comfort, follow these ergonomic recommendations:

- The SP400X is designed for scan and print applications. It is not recommended to be worn when performing keyboarding or other office-related tasks.
- If you experience discomfort, discontinue use of the SP400X and notify your supervisor immediately. If you experience persistent or recurring pain or discomfort that you think may be related to using the SP400X, you should promptly consult a qualified physician and, if available, your company's health and safety department.
- Adjust the SP400X finger strap so it is snug, but not too tight. The wrist strap should have light tension to keep the device against the knuckles without pressure.
- Maintain a relaxed, neutral posture while using the SP400X. Avoid making a tight fist.
- Select a comfortable print location:
 - Print at heights between elbow and shoulder level whenever possible.
 - When printing at heights at or below elbow level, printing horizontally is recommended (on the top of the package, for example).
 - When printing at heights above elbow level, printing vertically is recommended (on the side of the package, facing you, for example).
 - When printing at heights lower than waist level, bending at the knees (not at the waist) is recommended.
 - To avoid extended reaches, slide packages close to you before scanning and printing.
- Minimize bending the wrist to position the SP400X. Position hand in a light, relaxed fist when using the SP400X.
- Make a light fist when printing to keep the fingers out of the way and help stabilize the hand around the rudder and finger strap.
- To ensure good quality prints on different types of packages and to ensure comfort, use light pressure to maintain contact with the package when printing. Applying more force will not improve print quality.
- The SP400X can be worn on the right or left hand and arm. You may alternate wearing the SP400X on the right and left hand and arm.
- When handling boxes, lift with both hands and use good lifting techniques.
- Change your posture during the day by varying your tasks:
 - If your job requires standing for long periods, then sit during breaks.
 - If your job requires standing in one position, place one foot on a box or a bar to shift your posture.
 - If your job requires standing in one position, use an anti-fatigue mat to improve comfort.
 - If your job requires you to walk, use cushioned insoles in your shoes to improve comfort.
- If gloves are worn while using the SP400X, ensure they fit properly. The gloves should conform to your fingers and not significantly bunch under the finger strap. The finger length of the gloves should be as

8. Maintain the SP400X

Order supplies and accessories

Use the information in this section to order replacement print cartridges and other supplies. The SP400X is designed to enable easy, in-the-field replacement of heavily-used components.

TABLE 8-1 Supplies

Item	Description	Part number
Handheld 400 Series Finger Strap, 25 Pk	Field-replaceable front straps	CE196A
Handheld 400 Series Wrist Strap, 25 Pk	Field-replaceable wrist straps	CE197A
Handheld 400 Series Hand Mount	Allows hands free use of Handheld SP400XX SP400X	CE192A
Handheld 400 Series Extended Life Battery	Extra long life wrist-mounted battery	CE199B
Handheld 400 Series Extended Life Battery Wrist Case	Wrist case for extended life battery	CE200A
Handheld 400 Series Battery Cable	Connects battery to hand mount	CE203B
Charger for Handheld 400 Series Battery	5 bay smart battery charger	CDE11403053
Handheld 400 Series Extended Battery Adapter	Fits extended life battery to battery charger	CG021A
Handheld 400 Series Cartridge Door	Replacement print cartridge door	CE204A
Handheld 400 Series 5 Bay Cradle	5 bay Handheld SP400XX storage unit	CE194A
Handheld 400 Series Rear Buckle, 20 Pk	Replacement rear buckle	CE205A
Magenta Print Cartridges		CC602A
Handheld SP400X Series Handle	Handle accessory for use with Handheld SP400XX SP400X	

Handheld also offers extended warranty and service for the SP400X.

Condition the battery

For best results, condition new batteries before they are used. To condition batteries, follow the instructions that came with your battery charger.

Clean the SP400X



CAUTION: Unplug the battery from the SP400X before doing any cleaning procedure.



CAUTION: Never spray or douse the SP400X with any liquid. Use only dampened wipes, cloths, or swabs to clean the SP400X.



IMPORTANT: Use only materials from the list below to clean the SP400X (see "CLEANING MATERIALS" below). Other solvents or cleaners may damage the plastic, paint, or the adhesives used in the SP400X.

Cleaning materials

The following materials may be used to clean the SP400X:

- Cotton cloths
- Cotton swabs
- Baby wipes
- Deionized water
- Eyeglass cleaning wipes (anti-static and anti-fog types only)

Clean outside surfaces



Use a cotton cloth dampened with water to clean the outside surfaces of the SP400X.

- To remove difficult material, such as gummy adhesive or built-up grime, use a cotton cloth dampened with deionized water or use a baby wipe, and dry with a dry cotton cloth.
- To clean hard-to-reach places, such as the cooling ribs of the case, use cotton swabs dampened with deionized water.

Clean the imager window

Use eyeglass cleaning wipes to clean the imager window. Eyeglass cleaning wipes provide the best anti-glare cleaning solution.

- Be sure to wipe away any build-up from the center area of the imager window.
- Cotton swabs may be used to lightly remove smudges from the window edges.

NOTE: If eyeglass cleaning wipes are not available, use a cotton swab dampened with deionized water to clean the imager window.

Clean the wrist case and hand mount

Use a baby wipe or a cotton cloth dampened with deionized water to scrub all areas of the hand mount, straps, and wrist case that have come into direct contact with the skin.

Clean the door

To clean the opening in the door, do the following:

! **IMPORTANT:** Do not touch the metal contacts or the ink nozzles.

1. Remove the print cartridge from the door.
2. Use a dry cotton cloth to remove the ink-soaked fibers from the opening in the door.
3. If the ink is too dry to easily remove the fibers, use a cotton swab dampened with deionized water to break down the ink buildup.

Charge the battery

To charge batteries, follow the instructions that came with your battery charger.

Remove the hand mount or handle accessory

1. Squeeze both of the release buttons on the back of the hand mount.
2. Slide the hand mount backward, off of the SP400X.

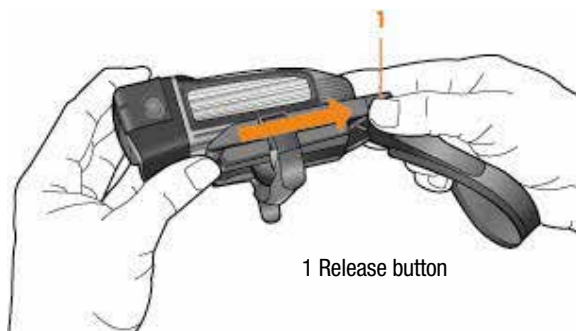

IMPORTANT: If you are using the handle accessory instead of the hand mount, see the instructions that were included with the handle accessory.

Replace the battery cable

1. Remove the hand mount from the SP400X. See "REMOVE THE HAND MOUNT OR HANDLE ACCESSORY" above.
2. Remove the battery cable by lifting up.
3. Insert a new battery cable..

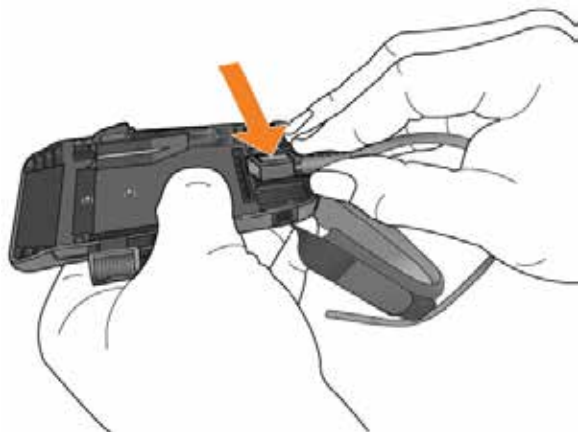

4. Reinstall the hand mount.

Replace the finger strap

1. Remove the hand mount. See "REMOVE THE HAND MOUNT OR HANDLE ACCESSORY."
2. Remove the finger strap by lifting the old buckles out of the notches.

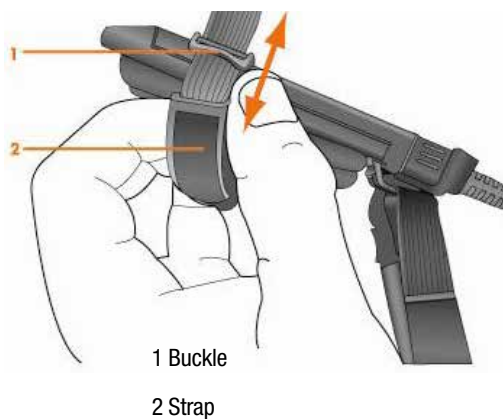

3. Insert a new finger strap by snapping each buckle into its notch.
4. Reinstall the hand mount.

Replace the wrist strap

NOTE: This procedure can be done without removing the hand mount.

1. Release the wrist strap fastener ends.
2. Pull the old wrist strap through the buckle.
3. Insert the new wrist strap.



1 Wrist strap

2 Buckle

! **IMPORTANT:** Make sure the fastener strap is on the outside of the wrist strap, away from the skin.

Replace the rear buckle

NOTE: This procedure can be done without removing the hand mount.

1. Grasp the buckle firmly and push it toward the gel pad until it releases.
2. Position the new buckle so it is angled as illustrated and press it into place.

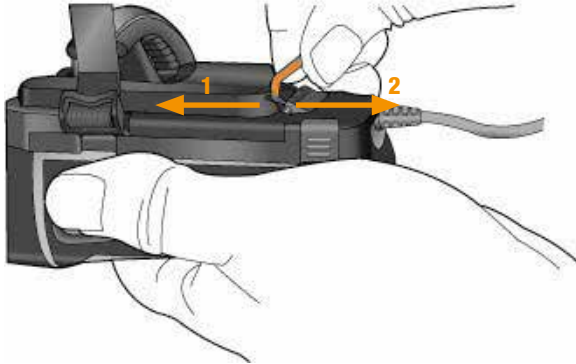

NOTE: The circled illustration, below, shows the buckle installed incorrectly. Note the angle of the buckle to the SP400X.



Replace the door

1. Remove the old door by opening the door 90 degrees and then pulling away to disengage the hinge.

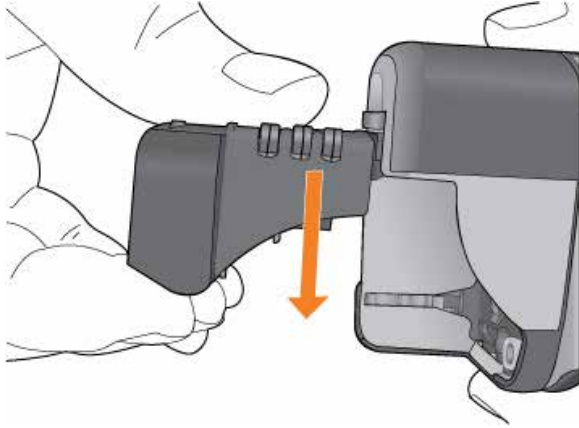

2. Replace with a new door by aligning the hinge and pressing the hinge onto the metal pin.

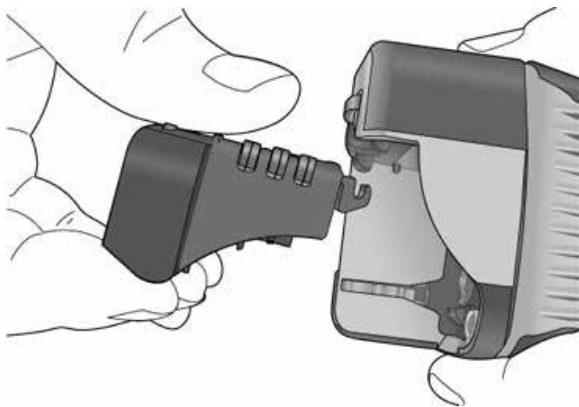

Recycle

Handheld encourages customers to recycle used electronic hardware, Handheld original cartridges, and rechargeable batteries.

Locate the serial number

The SP400X serial number is located on the product regulatory and identification label, on the bottom of the SP400X. Remove the hand mount to view the label on the bottom of the metal case.

The battery serial number is located on the product regulatory and identification label, on the bottom surface of the battery.

The battery charger serial number is located in the upper-right portion of the product regulatory and identification label, on the bottom of the battery charger.

9. Troubleshoot problems and get support

Problems powering on the SP400X

FIGURE 9-1 Problems powering on the SP400X

Problem indicator	Cause	Solution
The SP400X will not power on <i>Green power light doesn't stay on</i>	The green power button was not pushed.	Press the green power button.
	The battery is depleted.	Recharge the battery.
		Replace the battery.
	The battery is not plugged in correctly.	Ensure that the battery cable is pushed all the way into the battery.
		Ensure that the battery cable is pushed all the way into the battery.
	The SP400X is not seated properly onto the hand mount.	Ensure that the SP400X is fully pushed onto the hand mount.
		Check that the USB cover is not interfering with the seating of the hand mount.
The battery cable needs to be replaced.	Replace the battery cable.	
The hand mount needs to be replaced.	Replace the hand mount.	

Problems connecting the SP400X to a wireless network

FIGURE 9-2 Problems connecting the SP400X to a wireless network

Problem indicator	Cause	Solution
The SP400X is not associating with the access point <i>Fast blinking blue light</i> <i>Slow blinking green power light</i>	The access point may not be powered on.	Verify that the access point is on.
	The SP400X may be out of range of the access point.	Move closer to the access point.
		Access points may need to be relocated or added.
	The network settings may not be compatible between the SP400X and access point.	Verify the connectivity settings between the SP400X and the access point.
		Ensure that the DHCP server is active.
Ensure that the device is on the same subnet as the access point.		
Slow server response resulting from	Move closer to the access point.	

FIGURE 9-2 Problems connecting the SP400X to a wireless network

Problem indicator	Cause	Solution
	a weak signal between the SP400X and the access point.	Access points may need to be relocated or added.
	The network is overloaded	Reduce number of SP400Xs or other traffic on the network or expand the network's capabilities.
The SP400X is not communicating with the application server	The network settings may not be compatible with the SP400X.	Verify that the SP400X is set for the appropriate server address.
	<i>Slow blinking blue light; solid green power light (during initial start up this light may be blinking slow)</i>	Ensure that the server is on the same subnet as the access point.
		Ensure that the correct UDP port is assigned.
	The server is not responding.	Verify that the server's power is on and that it is available.
	<i>Slow blinking blue light; solid green power light (during initial start up this light may be blinking slow)</i>	Verify that the firewall setting is turned off or allows device traffic.
	The device is performing a firmware update.	Wait for the firmware update to complete. See "Update firmware wirelessly" in the Advanced use section
	<i>Slow blinking blue light; slow blinking green power light; fast blinking green tail lights</i>	

Problems scanning

FIGURE 9-3 Problems scanning

Problem indicator	Cause	Solution	
The SP400X will not scan <i>The red imager light does not illuminate.</i>	The SP400X may not be powered on <i>The green power light is not illuminated.</i>	Check that the SP400X is powered on. If the green power light does not stay illuminated, refer to the "Problems powering on" section	
	The SP400X may not be connected to the network <i>The blue wireless light is flashing.</i>	Check that the SP400X is connected to the network. If the blue wireless light does not stay illuminated, refer to the "Problems connecting to wireless network" section	
	The SP400X's ink cartridge door may be open. <i>Red tail lights and red warning light blinking slowly; solid orange ink cartridge light</i>		Close the door.
			Close the door and power cycle the SP400X. Turn off the device and replace the door.
	The ink cartridge is missing or bad. <i>Red tail lights and red warning light blinking quickly; solid orange ink cartridge light</i>		Turn off the SP400X open the ink cartridge door, and then reseal the ink cartridge.
			Turn off the SP400X and install a new ink cartridge.
The SP400X may not be seeing movement.		Move the SP400X so that it sees movement.	
		Increase the lighting in the work area.	
The SP400X takes a long time to acquire the bar code.	The imager window is obstructed.	Clean the imager window and inspect for scratches or cracks near the center of the window. See " CLEAN THE IMAGER WINDOW " in the Maintenance section	

FIGURE 9-3 Problems scanning

Problem	Cause	Solution
<i>The red imager light illuminates but the SP400X takes more than a few seconds to scan.</i>	The SP400X may be positioned too far from target.	Ensure that the SP400X is aimed directly at the target. Ensure that the SP400X is 2-12" away from the target.
	Invalid target or barcode. <i>Red scanning light will not turn off immediately after scan.</i>	Scan a different barcode or target to verify usage Ensure that the SP400X is configured to read this barcode or target
	The barcode or target is damaged or unreadable.	If available, scan another barcode or target.
Scans are not successful.	Poor scanning technique.	Make sure you are following the instructions in "SCAN," and "SCANNING TIPS."
	Damaged or poor print template quality.	If available, scan an alternate bar code. NOTE: It may be necessary to scan the Standard Product Default Settings bar code in "RESET THE STANDARD PRODUCT DEFAULTS" in the "Advanced use" section.
	The target surface is highly reflective (for example, tape or lamination).	Wait for the firmware update to complete. See "Update firmware wirelessly" in the Advanced use section
	Unrecognized bar code symbology.	It may be necessary to scan the Standard Product Default Settings bar code in "RESET THE STANDARD PRODUCT DEFAULTS" in the "Advanced use" section.

Problems printing

FIGURE 9-4 Problems printing

Problem	Cause	Solution
The SP400X does not print	The SP400X did not scan a valid barcode or target. <i>- If configured for this sequence -</i>	Check that the SP400X is powered on. If the green power light does not stay illuminated, refer to the "Problems powering on" section
		Check that the SP400X is connected to the network. If the blue wireless light does not stay illuminated, refer to the "Problems connecting to wireless network" section
	Print data from the server was not received. <i>Green tail lights did not turn on to indicate ready-to-print.</i>	Ensure wireless connectivity to the server. Refer to the 'Problems connecting to wireless network' section. <i>After a pause, red tail light flashes once with one beep, then slow blue blink immediately follows.</i>
		Verify that there should be a response from the server. It may be a no print message.
		Ensure that valid data was received from server. <i>Red tail lights flash twice</i>
	The print template is Invalid or missing. <i>Red tail lights blink slowly twice2x. The SP400X emits 3-4; low-high-mid tones 3x or 4x</i>	Ensure that the print templates are loaded correctly.
Reload the print templates. If a firmware upgrade was recently attempted, verify that the firmware upgrade completed.		
The SP400X timed out before the print was completed.	Scan again and complete the print more quickly, before the time out is reached.	

FIGURE 9-4 Problems printing

Problem	Cause	Solution
	<i>Red tail lights flash once and the SP400X emits a hi-low tone.</i>	Reconfigure the time out to provide more time for printing.
	The printer wheel on the SP400X was not in contact with the print surface for the duration of the print.	Ensure that the wheel is in contact with the print surface and rolls for the duration of print.
	The ink cartridge is empty <i>Fast blinking red warning and tail lights; fast blinking orange ink light.</i>	Replace the ink cartridge.
	The door may be open. <i>Red tail lights and red warning light blinking slowly; solid orange ink cartridge light.</i>	Close the door.
		Close the door and power cycle the SP400X.
		Turn off the device and replace the door.
	There may be poor electrical contact between the ink cartridge and the SP400X. <i>Red tail lights and red warning light blinking quickly; solid orange ink cartridge light.</i>	Turn off the SP400X, remove the ink cartridge and wipe the ink cartridge contact pads.
		Turn off the SP400X, remove the ink cartridge and wipe the SP400X contact pads.
		Turn off the SP400X and replace the door.
	The ink cartridge is bad. <i>Red tail lights and red warning light blinking quickly; solid orange ink cartridge light</i>	Turn off the SP400X and replace ink cartridge.

Problems printing correctly

FIGURE 9-5 Problems printing correctly

Problem	Cause	Solution
Prints are faded or streaked.	The print cartridge is out of ink.	Replace the ink cartridge.
	The print cartridge is dried out due to age.	Replace the ink cartridge.
	There is a faulty connection between the print cartridge and the SP400X.	Replace the ink cartridge.
The printed image skips (e.g., there are gaps between parts of the print).	SP400X is moved over heavily corrugated cardboard	Locate as smooth a printing location as possible.
	Poor printing technique.	Make sure you are following the instructions in "SCAN" and "PRINTING TIPS."
There are blank lines in the printed image.	The opening in the door is partially blocked.	See "CLEAN THE DOOR."
The ink smears while printing.	Wheels on the door are broken or missing.	Replace the door. See "REPLACE THE DOOR."
Ink drips are present on the printed surface.	Ink and fibers may be accumulating on the print cartridge and/or the door.	Clean the door. See "CLEAN THE DOOR."
		If cleaning the door does not solve the problem, replace the cartridge with a new one.

FIGURE 9-5 Problems printing correctly

Problem	Cause	Solution
The print smears after printing.	The ink is not dry.	<ul style="list-style-type: none"> • Allow more time for the ink to dry. • Try to avoid printing on surfaces that take longer to dry, such as plastic sleeves, tape, etc. • Increase air flow in the area. • Make sure the printed surface is dry. • Increase the temperature in the area. • Lower the humidity of the area • Change to Fast Dry template.
	The ink is not dry due to stacking or contact with other objects.	Allow the ink to dry before placing printed materials on top of or next to each other.
Print rubs off	The printing was done on a non-porous material.	Allow the ink to dry before placing the printed area in contact with other objects.

Errors and warning conditions

General errors and warning conditions

TABLE 9-2 Critical error





Visual feedback		Audio	Cause	Solution
	Solid, red Error light	Hi tone, 3x.	Critical error	SP400X needs to be serviced.
	Solid, red tail lights NOTE: Other lights may be on (blinking or solid) also.			

TABLE 9-3 Update failure (only applicable following wireless update attempt)*

Visual feedback		Audio	Cause	Solution
	Solid, red Error light	Hi tone, 3x.	Critical error	SP400X needs to be serviced.
	Solid, red tail lights NOTE: Other lights may be on (blinking or solid) also.			

*This will be seen the next time the SP400X is turned on after a wireless update attempt. The green Power light will also blink.

Battery errors and warning conditions

TABLE 9-4 Battery: Low

Visual feedback	Audio	Cause	Solution
 Slow blinking, orange Battery light	None	Battery low (configurable %)	Warning only. CAUTION: As the battery approaches very low, the light will blink faster and the Hi tone will sound every minute

TABLE 9-5 Battery: Low

Visual feedback	Audio	Cause	Solution
 Fast blinking, orange Battery light	Hi tone	Battery very low (configurable %)	Replace battery soon. CAUTION: As the battery approaches empty, the SP400X may shut down without warning.

TABLE 9-6 Battery: Empty, shutting down





Visual feedback	Audio	Cause	Solution
 Fast-blinking, red Error light	Hi tone	Empty, shutting down	Replace battery. NOTE: The SP400X may shut down without providing this feedback.
 Solid, orange Battery light			
 Fast-blinking, red tail lights			

TABLE 9-7 Battery: Battery level unknown

Visual feedback	Audio	Cause	Solution
 Solid orange Battery light	None	Battery level unknown	Warning only.

Print cartridge errors and warning conditions

TABLE 9-8 Print Cartridge: Bad installation



Visual feedback		Audio	Cause	Solution
	Fast-blinking, red Error light	Hi-Lo tone, 2x	Print cartridge error: <ul style="list-style-type: none"> • bad installation • missing cartridge • bad cartridge 	Ensure that the print cartridge is seated correctly. Ensure that the door is closed. If problem persists, replace the print cartridge.
	Solid, orange Battery light			
	Fast-blinking, red tail lights			

TABLE 9-9 Print cartridge opening or closing error



Visual feedback		Audio	Cause	Solution
	Fast-blinking, red Error light	Hi-Lo tone, 5x	Error occurred in the opening or closing of the print cartridge	Press the CLEAR button. If the problem persists, turn the SP400X off and then on again.
	Solid, orange Print Cartridge light			
	Fast-blinking, red tail lights			

TABLE 9-10 Print Cartridge: Door ajar



Visual feedback		Audio	Cause	Solution
	Slow blinking, red Error light	Mid tone, 3x	Door ajar or damaged	Ensure door is closed.
	Solid, orange Print Cartridge light		Door damaged	Replace door. See “REPLACE THE DOOR.”
	Fast-blinking, red tail lights			

TABLE 9-11 Print Cartridge: Ink level unknown

Visual feedback		Audio	Cause	Solution
	Solid, orange Print Cartridge light	None	Ink level unknown	Warning only.

TABLE 9-12 Print Cartridge: Ink low

Visual feedback	Audio	Cause	Solution
 Slow blinking, orange Print Cartridge light	None	Ink low (configurable %)	Warning only.

TABLE 9-13 Print Cartridge: Ink very low





Visual feedback	Audio	Cause	Solution
 Fast blinking, orange Print Cartridge light	Hi tone	Ink very low (configurable %)	Replace print cartridge soon. NOTE: As long as printing continues, the audio tone will be heard at approximately 1 minute or intervals.

TABLE 9-14 Print Cartridge: Ink cutoff/out reached

Visual feedback	Audio	Cause	Solution
 Fast blinking, red Error light	Hi tone, 3x	Ink cutoff/out reached (configurable %)	Replace print cartridge.
 Fast blinking, orange Print Cartridge light			
 Fast-blinking, red tail lights			

Scanning/Wireless errors and warning conditions

TABLE 9-15 Scanning/Wireless: Wireless network unavailable



Visual feedback		Audio	Cause	Solution
	Fast blinking, blue Wireless light	Hi-Lo tone	The wireless network is unavailable.	Verify that the network settings on the SP400X match the settings of your wireless network access point. These settings must include the ESSID, security mode (WPA-PSK, WEP or none) and network key. If the problem persists, contact your network administrator.
	Slow blinking green Power light			

TABLE 9-16 Scanning/Wireless: Application server unavailable

Visual feedback		Audio	Cause	Solution
	Slow blinking, blue Wireless light	Hi-Lo tone	The wireless network is unavailable.	Verify that your network has a DHCP server. If the network does not have a DHCP server, you must configure the SP400X for static IP addressing (see “SET UP THE WIRELESS NETWORK” in the “Advanced use” section). Verify that the server addresses are set up correctly (see “CONFIGURE THE SERVER” in the “Advanced use” section). If problem persists, contact your network administrator.
			The application server is unavailable.	Verify that the application server is running. If the problem persists, contact your network administrator.

TABLE 9-17 Scanning/Wireless: Server error (immediately following successful scan)

Visual feedback		Audio	Cause	Solution
	Red tail lights, blink 1x	Hi-Lo tone	Server error	Try to scan again.

TABLE 9-18 Scanning/Wireless: Invalid bar code or bad data

Visual feedback		Audio	Cause	Solution
	Red tail lights, blinking 2x	Hi-Lo tone	Invalid bar code or bad data was sent to the server.	<ol style="list-style-type: none"> 1 Check the bar code. 2 Try to scan again. 3 If the problem persists, contact your supervisor.

TABLE 9-19 Scanning/Wireless: Incomplete print (after 'Ready to Print'*)



Visual feedback	Audio	Cause	Solution
 Red tail lights, blink 1x	Hi-Lo tone	Incomplete print timeout (configurable timeout)	Rescan and print.

TABLE 9-20 No print template

Visual feedback	Audio	Cause	Solution
 Red tail lights, slow blink, 2x	Lo-Hi-Mid tone, 3x or 4x	There is no print template loaded on the SP400X.	Load the desired print template.

Support services

If you have a problem, follow these steps:

1. Check the documentation that came with the product.
2. Visit the Handheld online support Web site at www.handheldgroup.com/manuals. Online support is available to all Handheld customers. It is the fastest source for up-to-date device information and assistance and includes the following features:
 - Access to qualified online support specialists
 - Valuable product and troubleshooting information for common problems
 - Current product notices, advisories
3. Contact your local Handheld representative.

10. Advanced use

System requirements

- SP400X device and accessories
- Wireless network and server application
- Computer with the following installed on it:
 - Windows® XP and Service Pack 2
 - Microsoft® .NET Framework 2.0 or later
 - Handheld SP400XX Series Configuration Software
 - Handheld SP400XX Series Template Design Software
- USB-compliant cable that does not exceed three meters (10 feet) in length, with a type B 5-pin plug at one end to connect to the SP400X's port

NOTE: If you are connected to the internet when you install the software and you do not have .NET Framework installed on your computer, .NET Framework will automatically be downloaded and installed.

Download and install software

Two software programs are required to configure the SP400X:

- Handheld SP400XX Series Configuration Software
- Handheld SP400XX Series Template Design Software

To download this software, visit www.handheldgroup.com/manuals.

Set up the wireless network

802.11b wireless

1. Connect the SP400X to a computer with a USB cable.
2. Use the Handheld SP400X Series Configuration Software to configure the 802.11b settings.
See "DOWNLOAD AND INSTALL SOFTWARE."
3. Select the Network tab and configure the SP400X to connect to your 802.11 network.
4. Select the Server tab and configure the SP400X to connect to your application server.

NOTE: See the Handheld SP400XX Series Configuration Software Users Guide for more detailed instructions and help. It is available at www.handheldgroup.com/manuals.

Configure the server

1. Select the Server tab.

NOTE: All IP addresses must be entered using IP address dot notation.

2. Enter the Primary Server IP address.
3. Enter the Primary Server Port.
4. Enter the Alternate Server IP address.
5. Enter the Alternate Server Port.
6. Enter the File Server IP address.
7. Enter the File Server Port.

Design print templates

Use the Handheld SP400X Series Template Design Software to design print templates for the SP400X.

1. Download the Handheld SP400X Series Template Design Software at www.handheldgroup.com/manuals.
2. Use the software to lay out dynamic data fields and static data and images for your template.

! **IMPORTANT:** The field name given to a dynamic text field and the field width must match the field name and width used by the server. The print template name must also match the print template name used by the server application.

4. Perform a print test if desired.
5. Save the template on your SP400X

NOTE: For more detailed instructions and help, see the **HANDHELD SP400X SERIES TEMPLATE DESIGN SOFTWARE USERS GUIDE**.

It is available at www.handheldgroup.com/manuals.

Use the default print templates

Four default print templates are already saved on the SP400X.

There are three non-wireless templates for use in demonstration mode (where a wireless connection is not used):

- System informat
- SP400X Demo print template
- Pen Diagnostic print template

There is one wireless print template (for use with a wireless connection):

- SP400X Default (wireless) print template



FIGURE 10-6 System information print template



FIGURE 10-7 sp400 Demo print template



FIGURE 10-8 Pen Diagnostic print template



FIGURE 10-9 sp400 Default (wireless) print template

NOTE: For a description of the information that is contained in the default print templates, see the Handheld SP400X Series Template Design Software Users Guide. It is available at www.handheldgroup.com/manuals.

To turn the SP400X on in demonstration mode, press the **CLEAR** button while pressing the **POWER BUTTON**.

To move between these print templates on the SP400X while in demonstration mode, press the **CLEAR** button. You will hear one Hi tone when the system information template is selected, two when the generic sp400 template is selected, and three when the nozzle health diagnostic template is selected, and so on.

The SP400X can save up to nine demonstration print templates if there is enough memory on the SP400X.

The system information print template and the nozzle health diagnostic print template contain information that is useful to service technicians when problems arise.

To restore the default templates, follow these steps:

1. Click **Printer** → **Restore to Factory Default Templates**.
2. Turn the SP400X off and then turn it back on.

Calibrate the scanner

The bar code scanning device in the SP400X is a model 5180 imager that was manufactured by Honeywell Imaging and Mobility. To understand the imager better or to modify settings, refer to the 5X80 Engine Series 5X10/5X80 User's Guide that can be downloaded at www.honeywell.com/aidc.

The 5X10/5X80 User's Guide contains configuration bar codes that can be used to customize the desired allowable bar codes and to change options and settings on the imager.

Reset the standard product defaults

If you are not sure what programming options are in your imager, or if you have changed some options and want the factory settings restored, scan the Standard Product Default Settings bar code, below.



FIGURE 10-10 Standard product default settings bar code.

NOTE: The light bar will briefly go out to indicate that the scan was completed successfully.

Update firmware through USB

1. Connect the SP400X to a computer with a USB cable.
2. Open the Handheld SP400X Series Configuration Software. See "DOWNLOAD AND INSTALL SOFTWARE."
3. Select the Update tab.

There are four types of firmware update files:

- Firmware: the main program running on the SP400X
- FPGA: the processor configuration
- Imager: the program running on the bar code scanner module
- Communication: the program running on the wireless communication module

4. In the File boxes, enter the names of the update files. You can use the Browse button to navigate to the update files.

NOTE: All of the update file names must have an ".hnp" extension.

5. Press the Write to Device button to begin the update process.
6. If you are doing a firmware or FPGA update, a dialog box instructing you to restart the SP400X appears:
 - a. Click OK to dismiss the dialog box.
 - b. Press the green Power button on the SP400X and hold for three seconds to turn the device off.
 - c. After the SP400X has turned off, restart it by pressing the Power button for one second.
 - d. When the connection status indicates that the device is connected again, restart the update process by clicking the Write To Device button.
7. A dialog box announcing that the update has been successful or has failed appears. If the update failed, try performing the update again before contacting support personnel.

NOTE: See the **HANDHELD SP400X SERIES CONFIGURATION SOFTWARE USERS GUIDE** for more detailed instructions and help. It is available at www.handheldgroup.com/manuals.

Update firmware wirelessly

If your SP400X is configured to communicate wirelessly, it will check with the file server for updates every time it is turned on. If a new update is available, it will download and install the new files automatically.

During the update process, the blue Wireless light blinks slowly and the green tail lights blink fast. The SP400X may automatically reboot more than once depending on the firmware updates needed. Be cautious to allow for the update process to complete.

- If the update is successful, the Wireless light stops blinking and remains solid.
- If the update fails, the red Error light, the red tail lights, and the green Power light blink 20 times quickly.

NOTE: The SP400X may print whether the update attempt was successful or not.

For more information about updating firmware, see the **HANDHELD SP400X SERIES CONFIGURATION SOFTWARE USER GUIDE**. It is available at www.handheldgroup.com/manuals.

11. SP400X specifications

General device specifications

The approximate dimensions at the widest part of the SP400X and hand mount are as shown in TABLE 11-21. The approximate weight is also shown in this table.

TABLE 11-21 General device specifications

Component	Width in. (mm)	Height in. (mm)	Length in. (mm)	Weight in oz
SP400X only	2.6 (65)	1.9 (47)	5.4 (136)	9.49
Hand Mount*	2.6 (66)	1.2 (31)	5.0 (126)	3.31
SP400X with hand mount	2.6 (66)	2.8 (71)	5.7 (145)	12.79

*Hand mount dimensions do not include straps or battery cable. Hand mount weight does include straps and battery cable.

Environmental specifications

TABLE 11-22 Environmental specifications

Feature	Specification
Operating temperature	-5 to 45 degrees C (23 to 113 degrees F)
Storage temperature	-40 to 55 degrees C (-40 to 131 degrees F)
Relative humidity	25 to 95 percent, non-condensing
Vibration	MIL-STD-810E
Altitude	1,200 feet (366 meters) below sea level to 15,000 feet (4,572 meters)

Wireless specifications

Range of wireless module

The typical wireless range is 100 feet (30.5 meters) or more within an office environment, and two to three times that distance in wide open spaces. The range depends greatly upon the design and use of the infrastructure. Interference from other RF devices, obstructions such as walls and trees, ambient noise levels, and the performance of other communications devices and their antenna selection and placement may all significantly impact the performance of the whole system.

Other specifications

TABLE 11-23 Other wireless specifications

Feature	Specification
Technology	IEEE 802.11 b/g/n, wireless compliant
Frequency	2.4 ~ 2.4835 GHz (US/Can/Japan/Europe) 2.471 ~ 2.497 GHz (Japan)
Modulation	DQPSK, DBPSK and CCK
Channels	11 channels – USA/Canada 13 channels – Europe 14 channels – Japan 4 channels - France
Data Rate	11, 5.5, 2, 1 Mbps
MAC	CSMA/CA with ACK, RTS, CTS
Protocols	TCP/IP, ARP, ICMP, DHCP, DNS, HTTP UDAP Discovery
Data transfer	TCP/IP, HTTP, UDP
RF power	+15 dBm (typical) Approximately 32 mW
Sensitivity	-82dBm for 11 Mbps -86dBm for 5.5 Mbps -88dBm for 2 Mbps -90dBm for 1 Mbps
Security	WEP (64 & 123 bit), WPA (PSK & TKIP)

The following list shows symbology types supported by the imager module. Refer to the manufacturer specifications to verify other supported symbologies not listed below.

TABLE 11-24 Symbology types

Australian Post
Aztec Code
British Post
Canadian Post
China Post
Codabar
Codablock F
Code 11
Code 16K
Code 2 of 5
Code 49
Code128

TABLE 11-24 Symbology types

Code39 (3of9)
Code93
Data Matrix
EAN-UCC Composite Codes
EAN/JAN-13
EAN/JAN-8
IATA Code 2 of 5
Interleaved 2 of 5
Japanese Post
Kix (Netherlands)Post
Korea Post
Matrix 2 of 5
MaxiCode
MicroPDF417
MSI
PDF417
Planet Code
Plessey Code
PosiCode A and B
Postnet
QR Code
RSS Expanded
RSS Limited
RSS-14
4-CB / 4 State / Intelligent Mail Barcode

12. Warranty and regulatory information

Warranty

If you have an existing service contract, see the contract for warranty information. If you do not have an existing service contract, see www.handheldgroup.com/manuals for information about your warranty.

Regulatory notices

U.S.A.

Federal Communications Commission notice

NOTE: This equipment has been tested and found to comply with the limits for a Class A digital device, pursuant to part 15 of the FCC Rules. These limits are designed to provide reasonable protection against harmful interference when the equipment is operated in a commercial environment. This equipment generates, uses, and can radiate radio frequency energy and, if not installed and used in accordance with the instruction manual, may cause harmful interference to radio communications. Operation of this equipment in a residential area is likely to cause harmful interference in which case the user will be required to correct the interference at his own expense.

This device complies with part 15 of the FCC Rules. Operation is subject to the following two conditions: (1) This device may not cause harmful interference, and (2) this device must accept any interference received, including interference that may cause undesired operation.

Cet appareil est conforme aux règles du chapitre 15 de la réglementation de la FCC. Son utilisation est soumise aux deux conditions suivantes : (1) il ne peut pas causer de perturbations électromagnétiques gênantes et (2) il doit accepter toutes les perturbations reçues, y compris celles susceptibles d'occasionner un fonctionnement indésirable.

Modifications

The FCC requires the user to be notified that any changes or modifications made to this device that are not expressly approved by Handheld may void the user's authority to operate the equipment.

Canada

This Class A digital apparatus complies with Canadian ICES-003.

Cet appareil numérique de la classe A est conforme à la norme NMB-003 du Canada.

European Union notices

Compliance with these directives implies conformity to harmonized European standards (European Norms) that are listed in the EU Declaration of Conformity issued by Handheld for this product or product family.

This compliance is indicated by one of the following conformity markings placed on the product. The following CE marking is valid for non-telecommunications products and for EU harmonized telecommunications products, such as 802.11B devices.



The following CE marking is valid for EU non-harmonized telecommunications products.



*If applicable, a notified body number is used. Refer to the regulatory label provided on this product. The telecommunications functionality of this product may be used in the following EU and EFTA countries:

Austria, Belgium, Cyprus, Czech Republic, Denmark, Estonia, Finland, France, Germany, Greece, Hungary, Iceland, Ireland, Italy, Latvia, Liechtenstein, Lithuania, Luxembourg, Malta, Netherlands, Norway, Poland, Portugal, Slovak Republic, Slovenia, Spain, Sweden, Switzerland and United Kingdom.

Products with 2.4-GHz wireless LAN devices

France

L'utilisation de cet équipement (2.4GHz wireless LAN) est soumise à certaines restrictions : cet équipement peut être utilisé à l'intérieur d'un bâtiment en utilisant toutes les fréquences de 2400 à 2483.5 MHz (Chaîne 1-13). Pour une utilisation en environnement extérieur, vous ne devez pas utiliser les fréquences comprises entre 2454 à 2483.5-MHz (Chaîne 10-13). Pour les dernières restrictions, voir <http://www.art-telecom.fr>.

For 2.4-GHz wireless LAN operation of this product, certain restrictions apply. This equipment may use the entire 2400-MHz to 2483.5-MHz frequency band (channels 1 through 13) for indoor applications. For outdoor use, the 2454-MHz to 2483.5-MHz frequency band (channels 10 through 13) may not be used. For the latest requirements, see <http://www.srt-telecom.fr>.

Italy

E' necessaria una concessione ministeriale anche per l'uso del prodotto. Verifici per favore con il proprio distributore o direttamente presso la Direzione Generale Pianificazione e Gestione Frequenze. License required for use. Verify with your dealer or directly with the General Directorate for Frequency Planning and Management (Direzione Generale Pianificazione e Gestione Frequenze).

Wireless LAN 802.11b devices



International

For regulatory identification purposes, your product is assigned a Regulatory Model Number. The Regulatory Model Number for your product is listed in the Declaration of Conformity. This regulatory number is different from marketing name and product number.