

ALGIZ 10X

QUICK START GUIDE



handheld

WHAT'S IN THE BOX

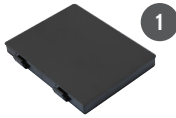

Ref.	Item	Description
1	Battery Pack	One 2 Cell Li-Ion Battery Pack
2	19V Adapter	19V Adapter w/ standard power cord. Standard type
3	Screen protector film	
4	Quick start guide	Algiz 10X Quick start guide

STARTING ALGIZ 10X

Note: you will be asked to enter your Microsoft Windows license number that is located under the main battery.

Press and hold power button for 4 seconds to power on the unit. Follow the on-screen instructions to get started with Windows. The screen calibration may not be accurate the first time you start the computer. Follow the procedure to calibrate the touchscreen.

INSERT BATTERY PACK

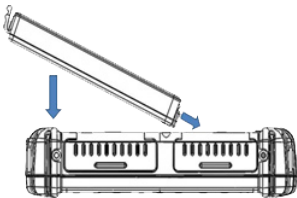

CAUTION - Please fully charge the battery in advance of operating Algiz 10X for the first time. New battery packs should be fully charged before Algiz 10X is disconnected from the external power source. It takes approximately 3 hours to fully charge the battery from empty.

SCREEN CALIBRATION

1. Open Control Panel > Hardware and Sound > Tablet PC Settings
2. Click Calibrate and follow instructions

Repeat step 1 and 2 until you are satisfied with the calibration.





FUNCTION KEYS



Ref.	Components	Description
1	Power Button*	Hold down for 4 seconds to turn the computer on
2	Menu	Menu button to control: brightness, volume, battery, power to modules, and system information
3	Up/Down/Left/ Right/OK Button	Control of up, down, left, right and Enter functions
4	F1, F2, 	3 programmable buttons. Press Menu to configure

* If computer does not respond you can power off by holding down the Power Button until the LEDs switches off. Hold down for about 10 seconds.

LED INDICATORS

Ref.	Symbol	Indicator Status Description
Power mode		Green: System is on No light: System is off or LED indicators are off in HotTab
Storage Status		Flashing green light: SSD is reading/writing data
Radio Status		Green: Indicates that any transmitting radio is turned on (WiFi, BT, WWAN)
Battery Status		Green: Full battery, Red: Low battery, Orange: Charging Flashing red: Running on Hot-swap battery
GPS Status		Green: Indicates GPS power on

REAR SIDE

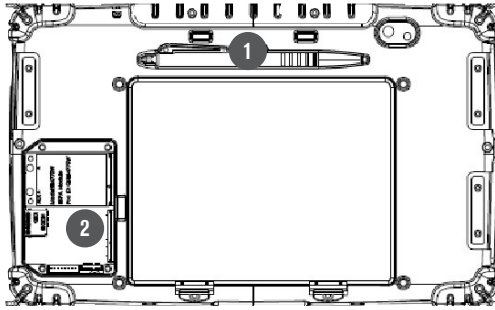

Ref.	Item	Description
1	Stylus Pen	-
2	Service Window	Expansion slots

LEFT AND RIGHT SIDE

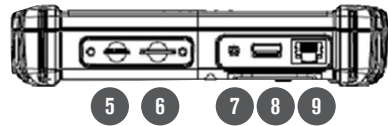
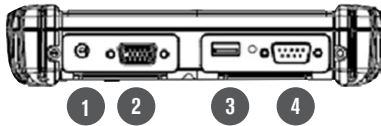

Ref.	Item	Description
1	DC Power Jack	-
2	VGA	For connecting external display devices such as monitors and projectors
3	USB 2.0 Port	-
4	RS232	Accepts external connections using the interface of RS232 (D-sub 9 pins)
5	Micro SD Card Slot	Accepts Micro SDXC (up to 2TB)
6	SIM Card Slot	-
7	Combo Audio Jack	Audio in and out
8	USB 3.0 Port	-
9	Ethernet (RJ45)	10/100/1000-based network

Please go to www.handheldgroup.com to download the full manual.